

PCS Band Single Polarization

Horizontal 65° 17.15dBi

PCS-SP-65-15(T0 / T2 / T6)

i. Electrical Specification

Frequency Range	1750 ~ 1870 MHz	
Band Width	120 MHz	
Gain	≥ 17.15 dBi ± 1dB (0°, 2°, 6°)	
Polarization	Vertical	
Beam width	Horizontal	65° ± 5°
	Vertical	9° ± 3°
F-B ratio	Horizontal (@180 ± 30°)	≥ 25 dB (0°, 2°, 6°)
	Vertical (@180 ± 60°)	≥ 25 dB (0°, 2°, 6°)
VSWR	≤ 1.3 : 1	
Impedance	50 Ω	
1st Upper Side lobe level	≥ 13 dB (0°, 2°, 6°)	
Maximum input power	≥ 200 W	

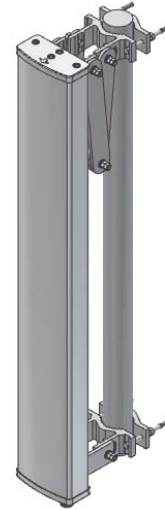

ii. Mechanical Specification

Radom Dimension (H x W x D)	1130 x 161 x 73 mm	
Weight (Include bracket)	≤ 6 kg	
Connector Type	7/16 DIN	
Withstand Wind Pressure	60 m/sec	
Radom Material (color)	A.S.A. (Cool Gray 4C) 	
Mechanical Down Tilt	0° ~ 20°	
Temperature	-40 °C ~ 70 °C	
Packing Size (H x W x D)	-	
Packing Weight	-	

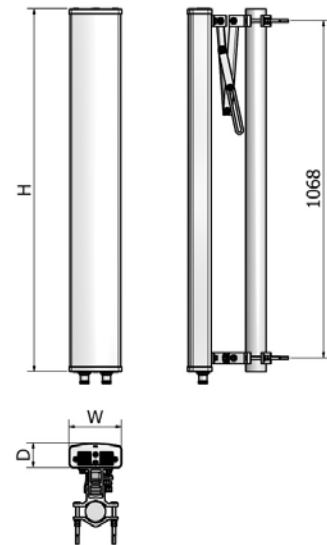

iii. Radiation Pattern

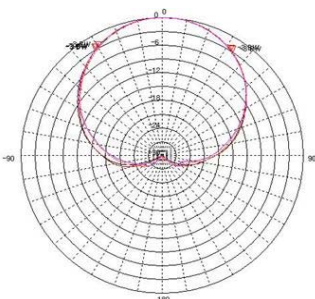

Horizontal Pattern

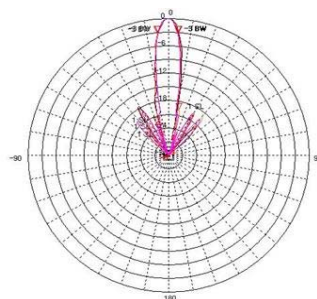

0°Tilt

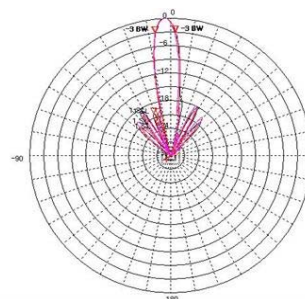

2°Tilt

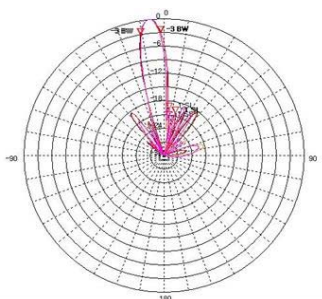

6°Tilt

Vertical Pattern