

# PCS Band Triple Polarization

Horizontal 65° 14.15dBi

PCS-TPH-65-12( T0 / T2 / T6 )

## i. Electrical Specification

Frequency Range	1750 ~ 1870 MHz	
Band Width	120 MHz	
Gain	≥ 14.15 dBi ± 1dB ( 0°, 2°, 6° )	
Polarization	± 45° SLANT, Vertical	
Beam width	Horizontal	65° ± 5°
	Vertical	18° ± 3°
F-B ratio	Horizontal (@180 ± 30°)	≥ 23 dB ( 0°, 2°, 6° )
	Vertical (@180 ± 60°)	≥ 23 dB ( 0°, 2°, 6° )
VSWR	≤ 1.5 : 1	
Impedance	50 Ω	
1st Upper Side lobe level	≥ 13 dB ( 0°, 2°, 6° )	
Maximum input power	≥ 200 W	

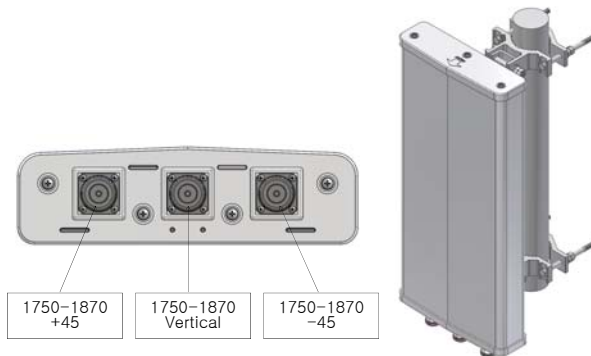

## ii. Mechanical Specification

Radom Dimension ( H x W x D )	583 x 261 x 70 mm	
Weight ( Include bracket )	≤ 7 kg	
Connector Type	7/16 DIN	
Withstand Wind Pressure	60 m/sec	
Radom Material (color)	A.S.A. (Cool Gray 4C) 	
Mechanical Down Tilt	0° ~ 20°	
Temperature	-40 °C ~ 70 °C	
Packing Size (H x W x D)	-	
Packing Weight	-	

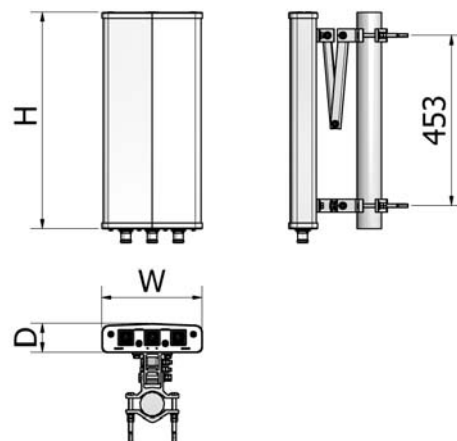

## iii. Radiation Pattern

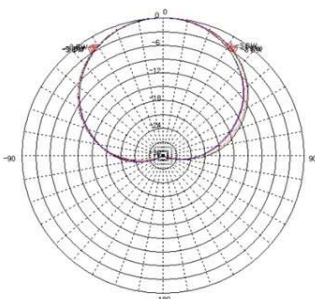

Horizontal Pattern

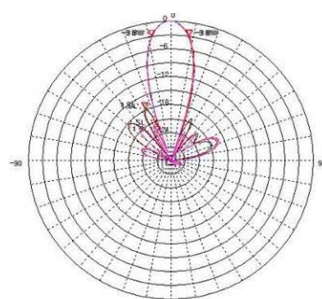

0°Tilt

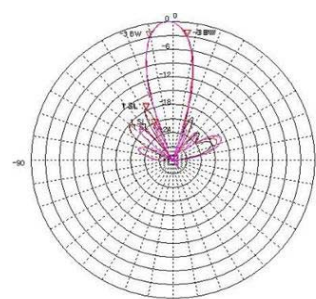

2°Tilt

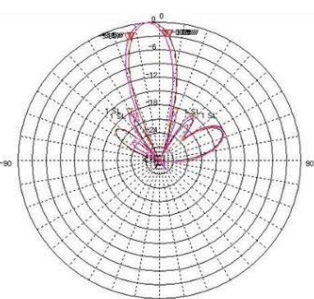

6°Tilt

Vertical Pattern